

[Return to Table of Contents](#)

KX SERIES

MEDIUM FORCE ROLLER SCREW ACTUATOR

Mount virtually any servo motor

Long stroke lengths available

High speed and long life



*Motors shown in photos
are for illustrative purposes
only and are not included
with KX Series Actuators*

KX Series

Linear Actuators

Exlar KX Series actuators offer advanced roller screw technology in varying performance levels and allow the use of third-party motors.

A Universal Design for Ultimate Flexibility

The KX Series actuator provides an ideal replacement for pneumatic and hydraulic cylinders in linear motion control applications. Unlike most suppliers who employ ballscrews, Exlar KX Series linear actuators utilize a planetary roller screw, assuring long life and high resistance to shock. This feature makes Exlar actuators far superior to alternative methods for applying all-electric linear actuation in industrial and military applications.

KX Series actuators are offered in 60, 75 and 90 mm frame sizes with dimensions and form-factor consistent with ISO Metric pneumatic cylinder specifications. This allows convenient substitution of Exlar actuators for existing pneumatic and hydraulic actuators.

KX Series actuators provides high performance planetary roller screw performance that is far superior to any other available rotary-to-linear conversion technologies. The KX Series is the ideal choice for demanding applications in industrial automation, mobile equipment, military, process control, or many other applications where millions of inches of travel under load is expected.

Operating Conditions and Usage

Operating Conditions and Usage		
Efficiency:		
Motor Inline	%	80
Motor Parallel	%	80
Ambient Conditions:		
Standard Ambient Temperature	°C	0 to 65
Extended Ambient Temperature*	°C	-30 to 65
Storage Temperature	°C	-40 to 85
IP Rating		IP65S

*Consult Exlar for extended temperature operation.

Technical Characteristics

Frame Sizes in (mm)	2.3 (60), 2.9 (75), 3.5 in (90)
Screw Leads in (mm)	0.19 (5), 0.4 (10)
Standard Stroke Lengths in (mm)	5.9 (150), 11.8 (300), 23.6 (600), 35.4 (900)
Force Range	up to 3,500 lbf (15 kN)
Maximum Speed	up to 32.8 in/sec (833 mm/s)

		KX60	KX75	KX90
Screw Lead Error	μm/1000 mm (in/ft)	G9: 200 (0.0024)	G9: 200 (0.0024)	G9: 200 (0.0024)
Screw Lead Backlash	mm (in)	0.10 (0.004)	0.10 (0.004)	0.10 (0.004)
Friction Torque Values	(Nm) lbf-in	0.34 (3)	0.56 (5)	0.56 (5)

The Exlar Advantage

Universal Mounting Options

The KX Series offers a wide variety of fixed and adjustable mounting accessories consistent with NFPA inch and ISO Metric pneumatic cylinder standards. The mounting options include:

- Front Flange
- Rear Flange
- Foot Mount
- Rear Eye
- Adjustable Side Trunnions
- Rear Clevis
- End Angles

Standard Actuator Construction

The standard KX Series actuator design includes an anodized aluminum housing offering a high level of corrosion resistance in many environments. The standard main rod is plated steel with a stainless steel rod end insert, providing excellent wear characteristics.

Sealed Body Design

The standard body design of the KX Series provides an IP54S sealed housing. IP65S sealing is standard when an inline or parallel motor mount is specified. This feature allows the actuator to be used in applications where water spray is present.

Motor Mounting Options

The KX Series allows for complete flexibility in the type and style of motor to drive the actuator. Types of motors compatible with KX Series actuators include DC motor, stepper, and servo motors. The KX Series can be ordered as a base unit without motor mounting, allowing you to manufacture your own mount.

For convenience these actuators are available with preconfigured motor mounts. Exlar maintains a large library of motor mounting dimension information for most manufacturers' servos and stepper motors.

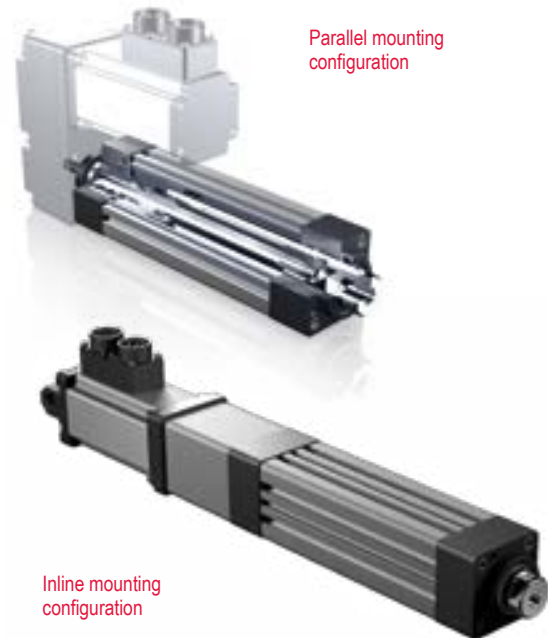

The inline mount places the motor on the input end of the actuator and allows the most compact form factor. In addition, Exlar offers a clevis mount attached to the rear of the inline-mounted motor for rear mounting.

The parallel motor mounts (side mount) utilize a belt drive system to transmit the motor torque to the actuator input shaft. Belt reductions of 1:1 and 2:1 are offered, allowing you to conveniently match the speed and output force to properly apply your KX Series actuator to your specific application.

KX Series Linear Actuators

Product Features

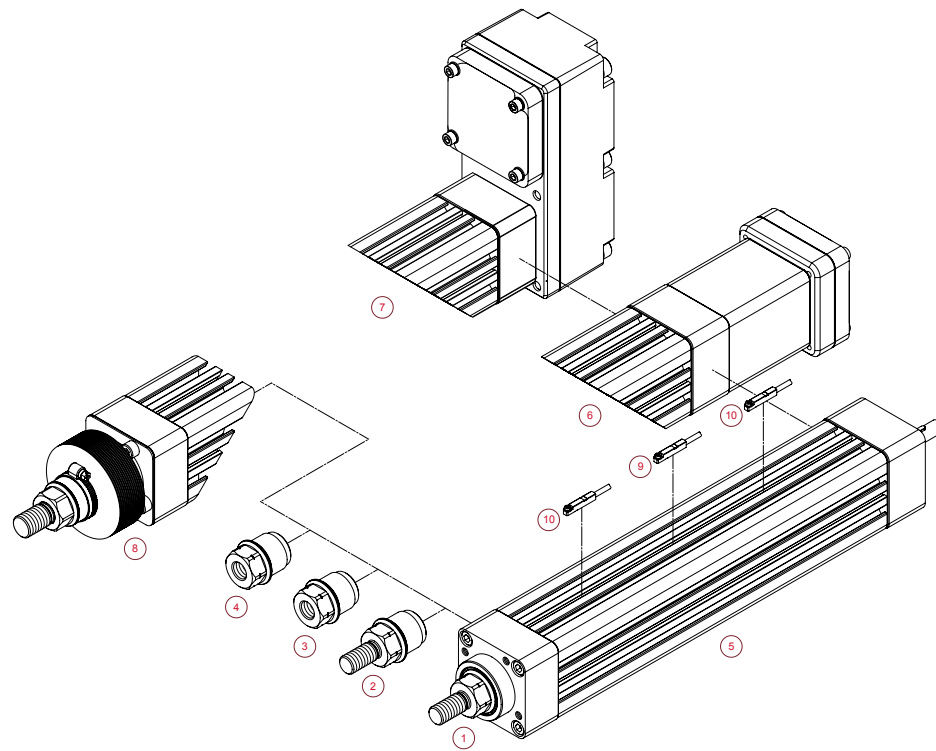
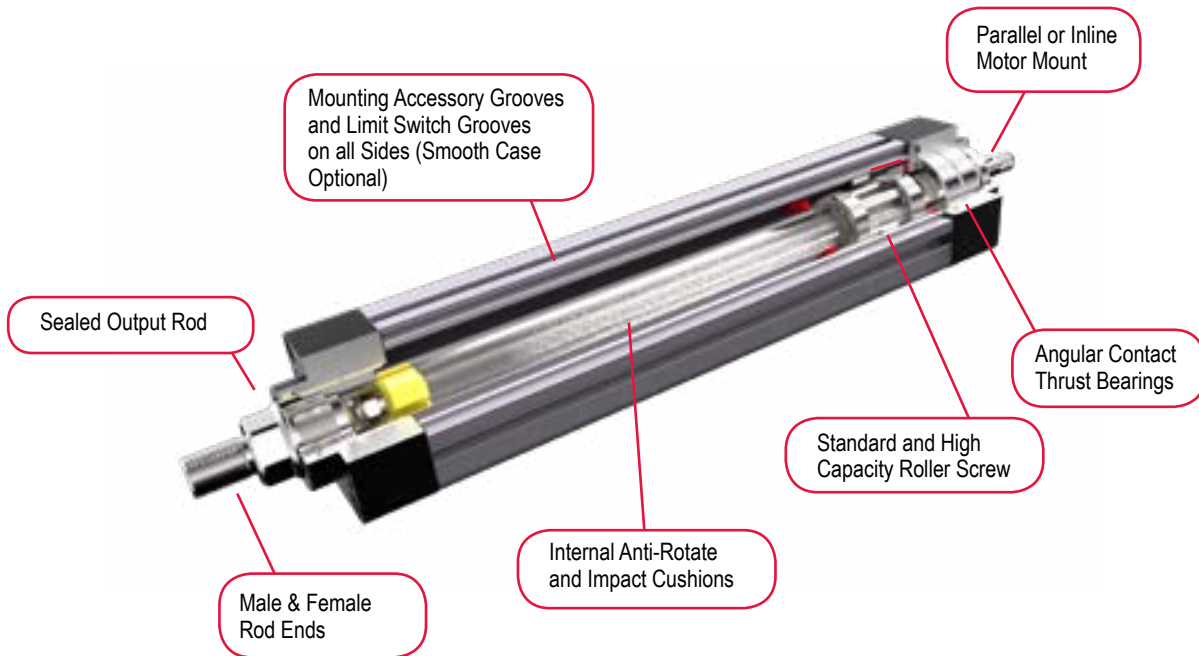

Industries and Applications

Hydraulic cylinder replacement
Ball screw replacement
Pneumatic cylinder replacement

Automotive

Dispensing
Automated assembly
Clamping

Food Processing

Packaging machinery
Pick and place systems

Machining

Automated flexible fixturing
Machine tool
Parts clamping
Automatic tool changers

Entertainment / Simulation

Motion simulators
Ride automation

Medical Equipment

Volumetric pumps

Plastics

Cut-offs
Die cutters
Molding
Formers

Material Handling

Indexing stages
Product sorting
Material cutting
Open / close doors
Web guidance
Wire winding
Pressing

Test

Test stands

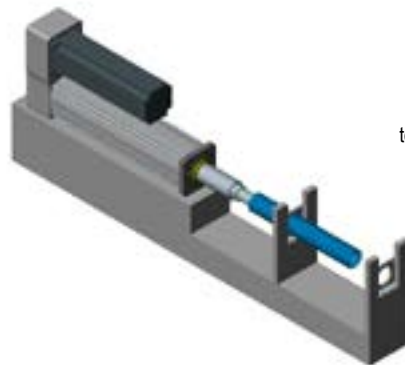

The smooth and accurate motion of Exlar's actuators combined with today's servo technology make multiple degree of freedom motion simulation applications easier to implement, cleaner and more efficient than hydraulic solutions.



DEFINITIONS:

Maximum Force: Calculated Cubic Mean Load for the application should not exceed this value. (Values are derived from the design capacity of the FT Series actuator and should not be exceeded or relied upon for continuous operation.)

Life at Maximum Force: Estimated life that can be expected from the actuator when running at Maximum Force for intermittent periods of time. (Theoretical calculation based on the Dynamic Load Rating of the actuator and using the Maximum Force rating as the Cubic Mean Load.)

C_a (Dynamic Load Rating): A design constant used when calculating the estimated travel life of the roller screw.

Maximum Input Torque: The torque required at the screw to produce the Maximum Force rating. Exceeding this value can cause permanent damage to the actuator.

Maximum Rated RPM: The maximum allowable rotational screw speed determined by either screw length limitations or the rotational speed limit of the roller screw nut.

Maximum Linear Speed: The linear speed achieved by the actuator when Maximum Rated RPM is applied to the roller screw input shaft.

Mechanical Specifications

KX60

Models	KX		
	05	10	
Screw Lead	in	0.1969	0.3937
	mm	5	10
Maximum Force ³	lbf	1350	675
	kN	6.0	3.0
Life at Maximum Force ¹	in x 10 ⁶	1.6	18.2
	km	41.7	461.4
C _a (Dynamic Load Rating)	lbf	2738	2421
	kN	12.2	10.8
Maximum Input Torque ²	lbf-in	53	53
	Nm	6	6
Max Rated RPM @ Input Shaft	RPM	5000	5000
Maximum Linear Speed @ Maximum Rated RPM	in/sec	16.4	32.8
	mm/sec	417	833

1. See page 169 for life calculation information.
2. Input torque should be limited such that Max Force is not exceeded. For a parallel belt ratio, the input torque ratings must be divided by the belt ratio for allowable motor torque. The output force ratings remain the same.
3. Maximum allowable actuator-generated force that can be applied routinely. Exceeding this force may result in permanent damage to the actuator. For maximum allowable externally-applied axial forces, consult factory. For high force, short stroke applications, consult factory.

Weights kg (lbs)

Base Actuator Weight (Zero Stroke)	lb	3.7
	kg	1.7
Actuator Weight Adder (Per mm of Stroke)	lb	0.017
	kg	0.008
Adder for Inline (excluding motor)	0.42 (0.93)	
Adder for Parallel Drive (excluding motor)	0.73 (1.6)	
Adder for Front Flange	0.42 (0.93)	
Adder for Rear Flange	2.16 (4.79)	
Adder for Rear Clevis	0.44 (0.98)	
Adder for Rear Eye	0.30 (0.67)	
Adder for Front/Rear Angle Mounts	0.24 (0.54)	
Adder for Two Trunnions	0.37 (0.82)	
Adder for Two Foot Mounts	0.45 (1)	

KX60 Inertias kg-m² (lbf-in-sec²)

	5 mm Lead	Add per 25 mm, 5 mm Lead
Base Unit - Input Drive Shaft Only	1.480 x 10 ⁻⁵ (1.31 x 10 ⁻⁴)	1.022 x 10 ⁻⁶ (9.045 x 10 ⁻⁶)
Inline Unit - w/Motor Coupling	2.702 x 10 ⁻⁵ (2.39 x 10 ⁻⁴)	1.022 x 10 ⁻⁶ (9.045 x 10 ⁻⁶)
	10 mm Lead	Add per 25 mm, 10 mm Lead
Base Unit - Input Drive Shaft Only	1.616 x 10 ⁻⁵ (1.43 x 10 ⁻⁴)	1.173 x 10 ⁻⁶ (1.038 x 10 ⁻⁶)
Inline Unit - w/Motor Coupling	2.837 x 10 ⁻⁵ (2.51 x 10 ⁻⁴)	1.173 x 10 ⁻⁶ (1.038 x 10 ⁻⁶)
Parallel Drive Inertias (P10 Option)		
	5 mm Lead	Add per 25 mm, 5 mm Lead
1:1 Reduction Parallel Belt Drive (66 mm)	4.339 x 10 ⁻⁵ (3.84 x 10 ⁻⁴)	1.022 x 10 ⁻⁶ (9.045 x 10 ⁻⁶)
1:1 Reduction Parallel Belt Drive (86 mm)	7.378 x 10 ⁻⁵ (6.53 x 10 ⁻⁴)	1.022 x 10 ⁻⁶ (9.045 x 10 ⁻⁶)
1:1 Reduction Parallel Belt Drive (96 mm)	8.564 x 10 ⁻⁵ (7.58 x 10 ⁻⁴)	1.022 x 10 ⁻⁶ (9.045 x 10 ⁻⁶)
2:1 Reduction Parallel Belt Drive (96 mm)	7.095 x 10 ⁻⁵ (6.28 x 10 ⁻⁴)	2.555 x 10 ⁻⁷ (2.261 x 1 ⁻⁶)
	10 mm Lead	Add per 25 mm, 10 mm Lead
1:1 Reduction Parallel Belt Drive (66 mm)	4.474 x 10 ⁻⁵ (3.96 x 10 ⁻⁴)	1.173 x 10 ⁻⁶ (1.038 x 10 ⁻⁶)
1:1 Reduction Parallel Belt Drive (86 mm)	7.514 x 10 ⁻⁵ (6.65 x 10 ⁻⁴)	1.173 x 10 ⁻⁶ (1.038 x 10 ⁻⁶)
1:1 Reduction Parallel Belt Drive (96 mm)	8.704 x 10 ⁻⁵ (7.70 x 10 ⁻⁴)	1.173 x 10 ⁻⁶ (1.038 x 10 ⁻⁶)
2:1 Reduction Parallel Belt Drive (96 mm)	7.129 x 10 ⁻⁵ (6.31 x 10 ⁻⁴)	2.931 x 10 ⁻⁷ (2.595 x 10 ⁻⁶)
Parallel Drive Inertias (Smooth Motor Shaft Option)		
	5 mm Lead	Add per 25 mm, 5 mm Lead
1:1 Reduction Parallel Belt Drive (66 mm)	6.015 x 10 ⁻⁵ (5.32 x 10 ⁻⁴)	1.022 x 10 ⁻⁶ (9.045 x 10 ⁻⁶)
1:1 Reduction Parallel Belt Drive (86 mm)	1.103 x 10 ⁻⁴ (9.76 x 10 ⁻⁴)	1.022 x 10 ⁻⁶ (9.045 x 10 ⁻⁶)
1:1 Reduction Parallel Belt Drive (96 mm)	2.176 x 10 ⁻⁴ (1.93 x 10 ⁻³)	1.022 x 10 ⁻⁶ (9.045 x 10 ⁻⁶)
2:1 Reduction Parallel Belt Drive (96 mm)	8.768 x 10 ⁻⁵ (7.76 x 10 ⁻⁴)	2.555 x 10 ⁻⁷ (2.261 x 10 ⁻⁶)
	10 mm Lead	Add per 25 mm, 10 mm Lead
1:1 Reduction Parallel Belt Drive (66 mm)	6.150 x 10 ⁻⁵ (5.44 x 10 ⁻⁴)	1.173 x 10 ⁻⁶ (1.038 x 10 ⁻⁶)
1:1 Reduction Parallel Belt Drive (86 mm)	1.117 x 10 ⁻⁴ (9.88 x 10 ⁻⁴)	1.173 x 10 ⁻⁶ (1.038 x 10 ⁻⁶)
1:1 Reduction Parallel Belt Drive (96 mm)	2.190 x 10 ⁻⁴ (1.94 x 10 ⁻³)	1.173 x 10 ⁻⁶ (1.038 x 10 ⁻⁶)
2:1 Reduction Parallel Belt Drive (96 mm)	8.802 x 10 ⁻⁵ (7.79 x 10 ⁻⁴)	2.931 x 10 ⁻⁷ (2.595 x 10 ⁻⁶)

*See definitions on page 123

KX75

Models	KX		
		05	10
Screw Lead	in	0.1969	0.3937
	mm	5	10
Maximum Force ³	lbf	2500	1250
	kN	11.1	5.6
Life at Maximum Force ¹	in x 10 ⁶	2.4	22.6
	km	60.7	573.3
C _a (Dynamic Load Rating)	lbf	5746	4820
	kN	25.6	21.4
Maximum Input Torque ²	lbf-in	98	98
	Nm	11	11
Max Rated RPM @ Input Shaft	RPM	4000	4000
Maximum Linear Speed @ Maximum Rated RPM	in/sec	13.1	26.2
	mm/sec	333	666

- See page 169 for life calculation information.
- Input torque should be limited such that Max Force is not exceeded. For a parallel belt ratio, the input torque ratings must be divided by the belt ratio for allowable motor torque. The output force ratings remain the same.
- Maximum allowable actuator-generated force that can be applied routinely. Exceeding this force may result in permanent damage to the actuator. For maximum allowable externally-applied axial forces, consult factory. For high force, short stroke applications, consult factory.

Weights kg (lbs)

Base Actuator Weight (Zero Stroke)	lb	6.75
	kg	3.06
Actuator Weight Adder (Per mm of Stroke)	lb	0.0235
	kg	0.0107
Adder for Inline (excluding motor)	1.12 (2.46)	
Adder for Parallel Drive (excluding motor)	1.84 (4.06)	
Adder for Front Flange	0.87 (1.91)	
Adder for Rear Flange	1.13 (2.49)	
Adder for Rear Clevis	0.84 (1.85)	
Adder for Rear Eye	0.84 (1.85)	
Adder for Front/Rear Angle Mounts	0.62 (1.37)	
Adder for Two Trunnions	0.71 (1.56)	
Adder for Two Foot Mounts	1.12 (2.47)	

KX75 Inertias kg-m² (lbf-in-sec²)

	5 mm Lead	Add per 25 mm, 5 mm Lead
Base Unit - Input Drive Shaft Only	9.26 x 10 ⁻⁵ (8.20 x 10 ⁻⁴)	3.13 x 10 ⁻⁶ (2.77 x 10 ⁻⁵)
Inline Unit - w/Motor Coupling	1.25 x 10 ⁻⁴ (1.11 x 10 ⁻³)	3.13 x 10 ⁻⁶ (2.77 x 10 ⁻⁵)
	10 mm Lead	Add per 25 mm, 10 mm Lead
Base Unit - Input Drive Shaft Only	9.48 x 10 ⁻⁵ (8.39 x 10 ⁻⁴)	3.32 x 10 ⁻⁶ (2.94 x 10 ⁻⁵)
Inline Unit - w/Motor Coupling	1.44 x 10 ⁻⁴ (1.28 x 10 ⁻³)	3.32 x 10 ⁻⁶ (2.94 x 10 ⁻⁵)
Parallel Drive Inertias (P10 Option)		
	5 mm Lead	Add per 25 mm, 5 mm Lead
1:1 Reduction Parallel Belt Drive (86 mm)	2.29 x 10 ⁻⁴ (2.03 x 10 ⁻³)	3.13 x 10 ⁻⁶ (2.77 x 10 ⁻⁵)
1:1 Reduction Parallel Belt Drive (96 mm)	3.19 x 10 ⁻⁴ (2.82 x 10 ⁻³)	3.13 x 10 ⁻⁶ (2.77 x 10 ⁻⁵)
1:1 Reduction Parallel Belt Drive (130 mm)	5.96 x 10 ⁻⁴ (5.28 x 10 ⁻³)	3.13 x 10 ⁻⁶ (2.77 x 10 ⁻⁵)
2:1 Reduction Parallel Belt Drive (130 mm)	2.82 x 10 ⁻⁴ (2.50 x 10 ⁻³)	7.83 x 10 ⁻⁷ (6.93 x 10 ⁻⁶)
	10 mm Lead	Add per 25 mm, 10 mm Lead
1:1 Reduction Parallel Belt Drive (86 mm)	2.31 x 10 ⁻⁴ (2.05 x 10 ⁻³)	3.32 x 10 ⁻⁶ (2.94 x 10 ⁻⁵)
1:1 Reduction Parallel Belt Drive (96 mm)	3.21 x 10 ⁻⁴ (2.84 x 10 ⁻³)	3.32 x 10 ⁻⁶ (2.94 x 10 ⁻⁵)
1:1 Reduction Parallel Belt Drive (130 mm)	5.98 x 10 ⁻⁴ (5.30 x 10 ⁻³)	3.32 x 10 ⁻⁶ (2.94 x 10 ⁻⁵)
2:1 Reduction Parallel Belt Drive (130 mm)	2.83 x 10 ⁻⁴ (2.51 x 10 ⁻³)	8.30 x 10 ⁻⁷ (7.36 x 10 ⁻⁶)
Parallel Drive Inertias (Smooth Motor Shaft Option)		
	5 mm Lead	Add per 25 mm, 5 mm Lead
1:1 Reduction Parallel Belt Drive (86 mm)	2.84 x 10 ⁻⁴ (2.51 x 10 ⁻³)	3.13 x 10 ⁻⁶ (2.77 x 10 ⁻⁵)
1:1 Reduction Parallel Belt Drive (96 mm)	4.25 x 10 ⁻⁴ (3.76 x 10 ⁻³)	3.13 x 10 ⁻⁶ (2.77 x 10 ⁻⁵)
1:1 Reduction Parallel Belt Drive (130 mm)	7.33 x 10 ⁻⁴ (6.48 x 10 ⁻³)	3.13 x 10 ⁻⁶ (2.77 x 10 ⁻⁵)
2:1 Reduction Parallel Belt Drive (130 mm)	3.32 x 10 ⁻⁴ (2.94 x 10 ⁻³)	7.83 x 10 ⁻⁷ (6.93 x 10 ⁻⁶)
	10 mm Lead	Add per 25 mm, 10 mm Lead
1:1 Reduction Parallel Belt Drive (86 mm)	2.86 x 10 ⁻⁴ (2.53 x 10 ⁻³)	3.32 x 10 ⁻⁶ (2.94 x 10 ⁻⁵)
1:1 Reduction Parallel Belt Drive (96 mm)	4.27 x 10 ⁻⁴ (3.78 x 10 ⁻³)	3.32 x 10 ⁻⁶ (2.94 x 10 ⁻⁵)
1:1 Reduction Parallel Belt Drive (130 mm)	7.35 x 10 ⁻⁴ (6.50 x 10 ⁻³)	3.32 x 10 ⁻⁶ (2.94 x 10 ⁻⁵)
2:1 Reduction Parallel Belt Drive (130 mm)	3.33 x 10 ⁻⁴ (2.94 x 10 ⁻³)	8.30 x 10 ⁻⁷ (7.35 x 10 ⁻⁶)

*See definitions on page 123

KX Series Linear Actuators

KX90

Models	KX		
		05	10
Screw Lead	in	0.1969	0.3937
	mm	5	10
Maximum Force ³	lbf	3500	1750
	kN	15.6	7.8
Life at Maximum Force ¹	in x 10 ⁶	7.1	90.4
	km	179.6	2295
C _a (Dynamic Load Rating)	lbf	11548	10715
	kN	51.4	47.7
Maximum Input Torque ²	lbf-in	137	137
	Nm	16	16
Max Rated RPM @ Input Shaft	RPM	3000	3000
Maximum Linear Speed @ Maximum Rated RPM	in/sec	9.8	19.7
	mm/sec	250	500

1. See page 169 for life calculation information.

2. Input torque should be limited such that Max Force is not exceeded. For a parallel belt ratio, the input torque ratings must be divided by the belt ratio for allowable motor torque. The output force ratings remain the same.

3. Maximum allowable actuator-generated force that can be applied routinely. Exceeding this force may result in permanent damage to the actuator. For maximum allowable externally-applied axial forces, consult factory. For high force, short stroke applications, consult factory.

Weights kg (lbs)

Base Actuator Weight (Zero Stroke)	lb	11.96
	kg	5.42
Actuator Weight Adder (Per mm of Stroke)	lb	0.0366
	kg	0.016

Adder for Inline (excluding motor)	1.51 (3.35)
Adder for Parallel Drive (excluding motor)	2.62 (5.80)
Adder for Front Flange	1.54 (3.40)
Adder for Rear Flange	2.86 (6.31)
Adder for Rear Clevis	1.45 (3.21)
Adder for Rear Eye	1.13 (2.49)
Adder for Front/Rear Angle Mounts	0.90 (1.97)
Adder for Two Trunnions	0.80 (1.768)
Adder for Two Foot Mounts	1.71 (3.78)

KX90 Inertias kg-m² (lbf-in-sec²)

	5 mm Lead	Add per 25 mm, 5 mm Lead
Base Unit - Input Drive Shaft Only	2.97×10^{-4} (2.63×10^{-3})	1.11×10^{-5} (9.80×10^{-5})
Inline Unit - w/Motor Coupling	3.84×10^{-4} (3.40×10^{-3})	1.11×10^{-5} (9.80×10^{-5})
	10 mm Lead	Add per 25 mm, 10 mm Lead
Base Unit - Input Drive Shaft Only	3.00×10^{-4} (2.66×10^{-3})	1.13×10^{-5} (1.00×10^{-4})
Inline Unit - w/Motor Coupling	3.87×10^{-4} (3.43×10^{-3})	1.13×10^{-5} (1.00×10^{-4})
Parallel Drive Inertias (P10 Option)		
	5 mm Lead	Add per 25 mm, 5 mm Lead
1:1 Reduction Parallel Belt Drive (96 mm)	5.12×10^{-4} (4.53×10^{-3})	1.11×10^{-5} (9.80×10^{-5})
1:1 Reduction Parallel Belt Drive (130 mm)	7.98×10^{-4} (7.07×10^{-3})	1.11×10^{-5} (9.80×10^{-5})
2:1 Reduction Parallel Belt Drive (130 mm)	3.41×10^{-4} (3.02×10^{-3})	2.77×10^{-6} (2.45×10^{-5})
	10 mm Lead	Add per 25 mm, 10 mm Lead
1:1 Reduction Parallel Belt Drive (96 mm)	5.15×10^{-4} (4.56×10^{-3})	1.13×10^{-5} (1.00×10^{-4})
1:1 Reduction Parallel Belt Drive (130 mm)	8.02×10^{-4} (7.10×10^{-3})	1.13×10^{-5} (1.00×10^{-4})
2:1 Reduction Parallel Belt Drive (130 mm)	3.42×10^{-4} (3.03×10^{-3})	2.82×10^{-6} (2.50×10^{-5})
Parallel Drive Inertias (Smooth Motor Shaft Option)		
	5 mm Lead	Add per 25 mm, 5 mm Lead
1:1 Reduction Parallel Belt Drive (96 mm)	6.18×10^{-4} (5.47×10^{-3})	1.11×10^{-5} (9.80×10^{-5})
1:1 Reduction Parallel Belt Drive (130 mm)	9.35×10^{-4} (8.27×10^{-3})	1.11×10^{-5} (9.80×10^{-5})
2:1 Reduction Parallel Belt Drive (130 mm)	3.91×10^{-4} (3.46×10^{-3})	2.77×10^{-6} (2.45×10^{-5})
	10 mm Lead	Add per 25 mm, 10 mm Lead
1:1 Reduction Parallel Belt Drive (96 mm)	6.21×10^{-4} (5.50×10^{-3})	1.13×10^{-5} (1.00×10^{-4})
1:1 Reduction Parallel Belt Drive (130 mm)	9.38×10^{-4} (8.30×10^{-3})	1.13×10^{-5} (1.00×10^{-4})
2:1 Reduction Parallel Belt Drive (130 mm)	3.92×10^{-4} (3.47×10^{-3})	2.82×10^{-6} (2.50×10^{-5})

*See definitions on page 123

Estimated Service Life

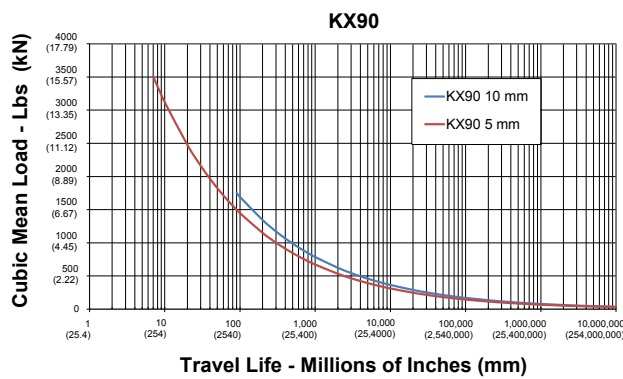
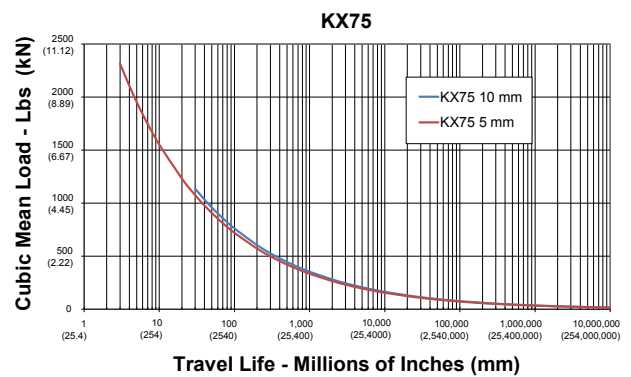
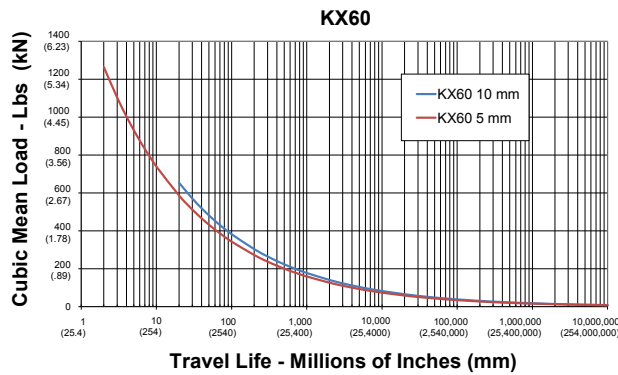

Service Life Estimate Assumptions:

- Sufficient quality and quantity of lubrication is maintained throughout service life (please refer to engineering reference on page 169 for lubrication interval estimates.)
- Bearing and screw temperature between 20° C and 40° C
- No mechanical hard stops (external or internal) or impact loads
- No external side loads
- Does not apply to short stroke, high frequency applications such as fatigue testing or short stroke, high force applications such as pressing. (For information on calculating estimating life for unique applications please refer to the engineering reference on page 169.

The L_{10} expected life of a roller screw linear actuator is expressed as the linear travel distance that 90% of properly maintained roller screws manufactured are expected to meet or exceed. This is not a guarantee and these charts should be used for estimation purposes only.

The underlying formula that defines this value is:
Travel life in millions of inches, where:

$$L_{10} = \left(\frac{C_a}{F_{cml}} \right)^3 \times \ell$$

C_a = Dynamic load rating (lbf)
 F_{cml} = Cubic mean applied load (lbf)
 ℓ = Roller screw lead (inches)

For additional details on calculating estimated service life, please refer to the Engineering Reference, page 169.

Data Curves

Critical Speed vs Stroke Length:

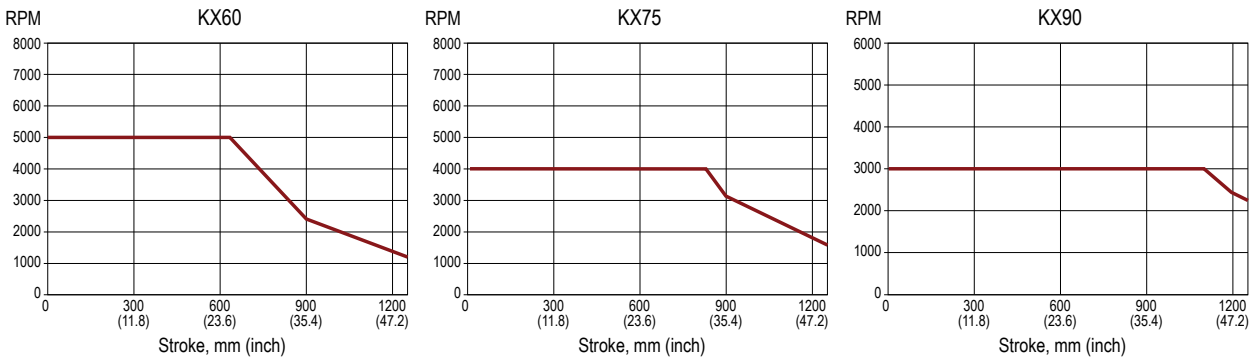

— Actuator Rated Speed
 speed at which we have tested and rated the actuator
 * With longer stroke length actuators, the rated speed of the actuator is determined by the critical speed

Maximum Side Load:

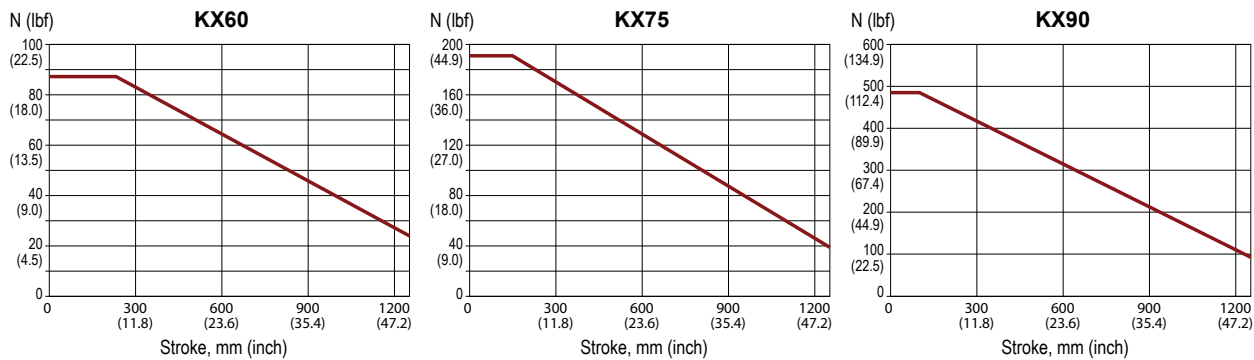

Rated Force vs Stroke:

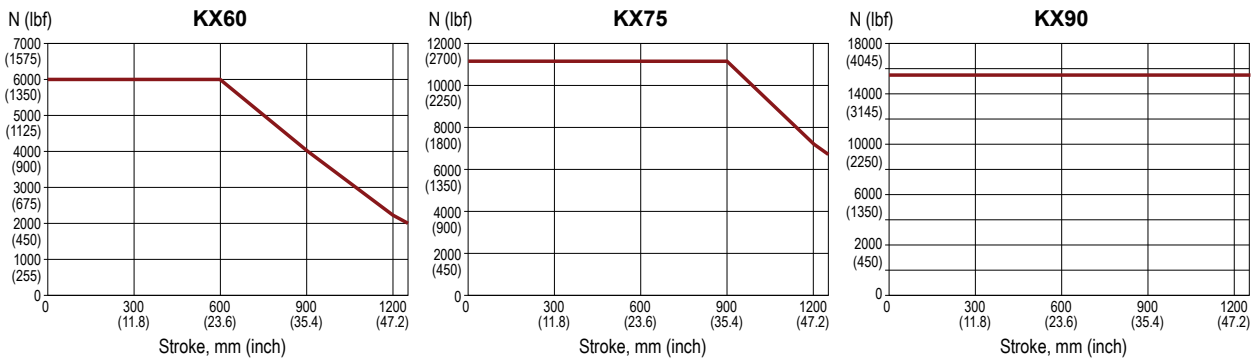

Options

PB = Protective Bellows

This option provides an accordion style protective bellows to protect the main actuator rod from damage due to abrasives or other contaminants in the environment in which the actuator must survive. The standard material of this bellows is S2 Neoprene Coated Nylon, Sewn Construction. This standard bellows is rated for environmental temperatures of -40 to 250 degrees F. Longer strokes may require the main rod of the actuator to be extended beyond standard length. Not available with extended tie rod mounting option. Please contact your local sales representative.

L1 ... L6 = Adjustable External Travel Switches

This option allows up to 3 external switches to be included. These switches provide travel indication to the controller and are adjustable.

KX Series Accessories

KX60	KX75	KX90	
			Mounting Attachments (including proper number of standard T nuts and screws)
KSRF-60-XX	KSRF-75-XX	KSRF-90-XX	Rear Flange Attachment (see drawings and table on next page)
KSFF-60	KSFF-75	KSFF-90	Front Flange Attachment
KSEA-60	KSEA-75	KSEA-90	End Angles, Stainless Steel Std (includes 2)*
KSEP-60	KSEP-75	KSEP-90	End Angles, Parallel, Stainless Steel Std (includes 2)
KSFM-60	KSFM-75	KSFM-90	Foot Mounts (includes 2)
KSST-60	KSST-75	KSST-90	Side Trunnions (includes 2)
KSRC-60	KSRC-75	KSRC-90	Rear Clevis (includes pins)
KSRE-60	KSRE-75	KSRE-90	Rear Eye
KSMT-60	KSMT-75	KSMT-90	Metric Side Trunnion
KSMC-60	KSMC-75	KSMC-90	Metric Rear Clevis (includes pins)
KSME-60	KSME-75	KSME-90	Metric Rear Eye
			Rod End Attachments
SRM050	SRM075	SRM075	Front Spherical Rod Eye, fits "M" Rod only
REI050	RE075	RE075	Front Rod Eye, fits "M" Rod only
RCI050	RC075	RC075	Front Rod Clevis, fits "M" Rod only
			Clevis Pins
KSRP-60	KSRP-75	KSRP-90	Clevis Pin for Front and Rear Clevis, Rod Eyes and Rod Clevis
KSMP-60	KSMP-75	KSMP-90	Metric Clevis Pin for Rear Metric Clevis, Metric Rod Eyes and Rod Clevis
Limit Switches (if required in addition to L1, L2, L3 option in actuator model)			
Option	Quantity	Part Number	Description
L1	1	43403	Normally Open PNP Limit Switch (10-30 VDC, 1m, 3 wire embedded cable)
L2	2	43404	Normally Closed PNP Limit Switch (10-30 VDC, 1m, 3 wire embedded cable)
L3	1	43403	Normally Open PNP Limit Switch (10-30 VDC, 1m, 3 wire embedded cable)
	2	43404	Normally Closed PNP Limit Switch (10-30 VDC, 1m, 3 wire embedded cable)
L4	1	67634	Normally Open NPN Limit Switch (10-30 VDC, 1m, 3 wire embedded cable)
L5	2	67635	Normally Closed NPN Limit Switch (10-30 VDC, 1m, 3 wire embedded cable)
L6	1	67634	Normally Open NPN Limit Switch (10-30 VDC, 1m, 3 wire embedded cable)
	2	67635	Normally Closed NPN Limit Switch (10-30 VDC, 1m, 3 wire embedded cable)

Consult your local sales representative to discuss maximum stroke length allowable with your final configuration.

Some accessories are available in stainless steel. Consult Exlar for availability and lead time.

* This option restricts max. load to 6.0 kN (1350 lbf) for K60, 8.9 kN (2000 lbf) for K75 and 9.3 kN (2100 lbf) for K90.

Dimensions

Base Actuator

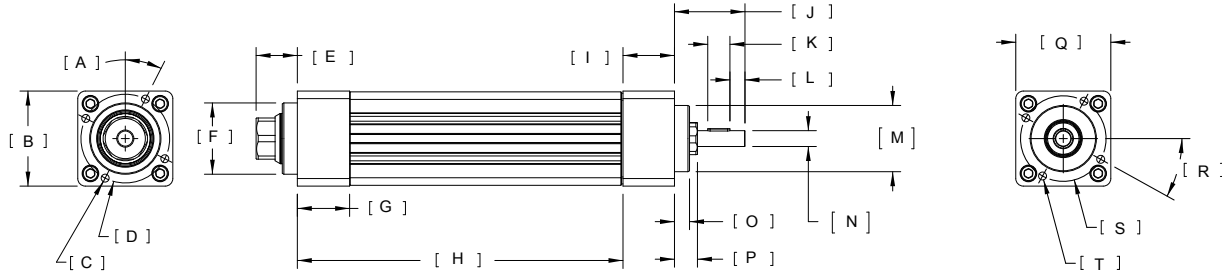

	KX60	KX75	KX90	
A	27°	28°	22.5°	
B	in	□ 2.362	□ 3.543	
	mm	60.00	75.00	90.00
C	in	N/A	N/A	N/A
	mm	∅ M6X1.0 _↓ 16.00	∅ M8X1.25 _↓ 16.00	∅ M10X1.5 _↓ 20.00
D	in	∅ 2.205 BC	∅ 2.677 BC	∅ 3.071 BC
	mm	56.00	68.00	78.00
E	in	1.025	1.300	1.611
	mm	26.04	33.03	40.91
F	in	∅ 1.77 +0.000/-0.001	∅ 2.05 +0.000/-0.001	∅ 2.44 +0.000/-0.001
	mm	∅ 45.00 +0.00/-0.03	∅ 52.00 +0.00/-0.03	∅ 62.00 +0.00/-0.03
G	in	1.299	1.457	1.693
	mm	33.00	37.00	43.00
H*	in	4.185	5.256	6.179
	mm	106.30	133.49	156.97
I	in	1.280	1.594	1.831
	mm	32.50	40.50	46.50
J	in	1.752	2.041	2.251
	mm	44.50	51.85	57.17

*Add stroke length to dimension

		KX60	KX75	KX90
K	in	0.551	0.760	0.787
	mm	14.00	19.31	20.00
L	in	0.374	0.591	0.728
	mm	9.50	15.00	18.50
M	in	∅ 1.646 +0.000/-0.002	∅ 2.045 +0.000/-0.002	∅ 2.440 +0.000/-0.002
	mm	41.81 +0.00/-0.05	∅ 51.94 +0.00/-0.05	∅ 62.00 +0.00/-0.05
N	in	∅ 0.394 +0.000/-0.001	∅ 0.472 +0.000/-0.001	∅ 0.629 +0.000/-0.001
	mm	10.00 +0.00/-0.03	∅ 12.00 +0.00/-0.03	∅ 16.00 +0.00/-0.03
O	in	0.374	0.472	0.472
	mm	9.50	12.00	12.00
P	in	0.571	0.691	0.681
	mm	14.50	17.54	17.29
Q	in	□ 2.362	□ 2.953	□ 3.543
	mm	60.00	75.00	90.00
R		29°	28°	22.5°
S	in	∅ 2.126 BC	∅ 2.677 BC	∅ 3.071 BC
	mm	54.00	68.00	78.00
T	in	N/A	N/A	N/A
	mm	∅ M6X1.0 _↓ 16.00	∅ M8X1.25 _↓ 21.50	∅ M10X1.5 _↓ 20.00

Trunnion Mount

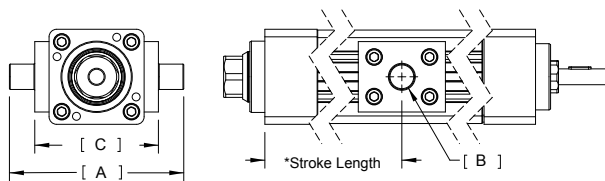

* Note: Approximate Distance for shipping. May be re-positioned by customer per application.

Version	A	∅B	C
KSST-60	4.928 in	1.000 +/- .001 in	3.073 in
KSMT-60	125.17 mm	16.00 -.03 mm/- .07 mm	78.05 mm
KSST-75	5.913 in	.999 + .000/- .002 in	3.913 in
KSMT-75	150.20 mm	19.97 +.00 mm/- .05 mm	99.40 mm
KSST-90	6.504 in	.999 + .000/- .002 in	4.504 in
KSMT-90	165.21 mm	19.97 +.00 mm/- .05 mm	114.40 mm

Mounting Accessories Ordered Separately

Parallel Mount (PXX or SXX)

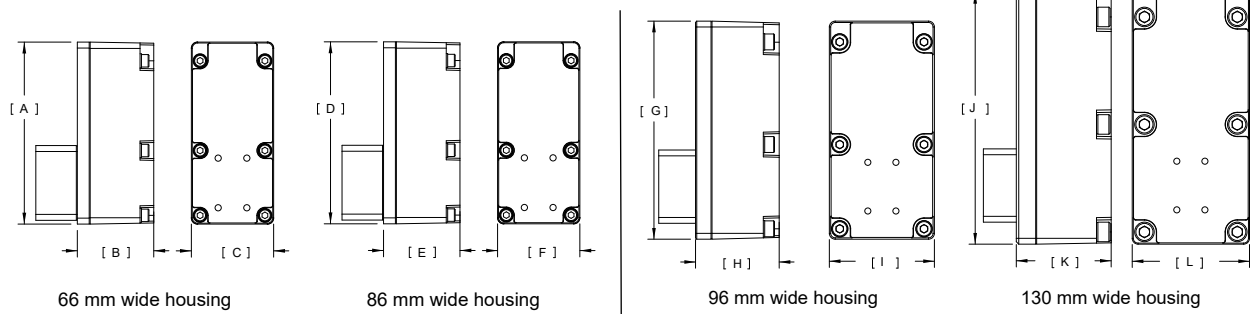

		DIM	KX60	KX75	KX90
A	in	5.748	X		
	mm	146.00	X		
B	in	2.414	X		
	mm	61.31	X		
C	in	2.598	X		
	mm	66.00	X		
D	in	7.028	X	X	
	mm	178.50	X	X	
E	in	2.696	X	X	
	mm	68.49	X	X	
F	in	3.386	X	X	
	mm	86.00	X	X	

		DIM	KX60	KX75	KX90
G	in	8.110	X	X	X
	mm	206.00	X	X	X
H	in	3.058	X	X	X
	mm	77.66	X	X	X
I	in	3.780	X	X	X
	mm	96.00	X	X	X
J	in	10.827		X	X
	mm	275.00		X	X
K	in	3.616		X	X
	mm	91.84		X	X
L	in	5.118		X	X
	mm	130.00		X	X

Parallel Mount Housing Width and Rear Flange/Clevis Mount Options

When selecting a parallel mount for your K Series actuator, the table at right indicates what size drive housing will be mounted to your actuator. If your application also requires a rear flange, rear clevis or rear eye, please select the appropriate attachment based on the size of the drive housing.

Actuator Frame Size	Mounted Motor Frame Size ¹	Belt Reduction Ratio	Parallel Drive Housing Width ²	Optional Rear Flange	Optional Rear Clevis	Optional Rear Eye
K60	60 mm	1:1	66 mm	KSRF-60-66		
	60 mm	2:1	96 mm	KSRF-60-96	KSRC-60 (English)/KSMC-60 (Metric)	KSRE-60 (English)/KSME-60 (Metric)
	60 mm	1:1 or 2:1	96 mm	KSRF-60-96		
K75	60 mm	1:1	86 mm	KSRF-75-86		
	90 mm	1:1	96 mm	KSRF-75-96	KSRC-75 (English)/KSMC-75 (Metric)	KSRE-75 (English)/KSME-75 (Metric)
	75 mm	2:1	130 mm	KSRF-75-130		
	115 mm	1:1	130 mm	KSRF-75-130		
K90	60 or 90 mm	1:1	96 mm	KSRF-90-96		
	60 mm	1:1 or 2:1	96 mm	KSRF-90-96	KSRC-90 (English)/KSMC-90 (Metric)	KSRE-90 (English)/KSME-90 (Metric)
	90 mm	1:1 or 2:1	130 mm	KSRF-90-130		
	115 mm	1:1	130 mm	KSRF-90-130		

¹ Motor sizes above are based on Exlar's product offering. Other manufacturers' motors of comparable size may also be mounted.

² See drawings for parallel drive housing dimensions.

Inline Integrated Coupling

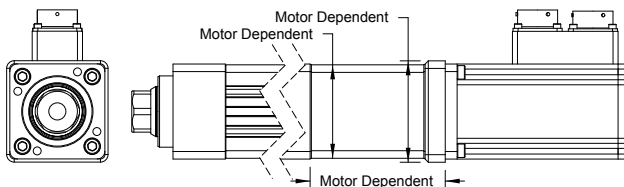

ISC keyed motor shaft recommended for inline mount

KX Series Linear Actuators

Foot Mount

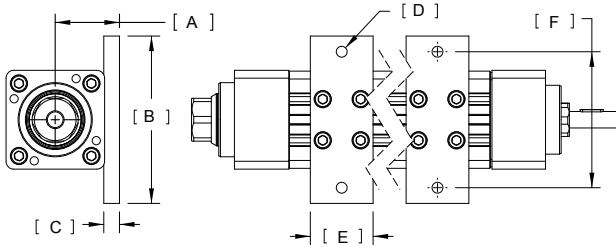

Mounting position shown for dimensions only.
Feet may be positioned on any side, at any distance.

		KSFM-60	KSFM-75	KSFM-90
A	in	1.536	1.969	2.502
	mm	39.03	50.00	63.55
B	in	4.0	4.921	5.669
	mm	101.6	125.00	144.00
C	in	0.375	0.512	0.750
	mm	9.53	13.00	19.05
D	in	Ø 0.260	Ø 0.354	Ø 0.433
	mm	6.60	9.00	11.00
E	in	1.50	1.969	1.750
	mm	38.10	50.00	44.45
F	in	3.250	3.937	4.724
	mm	82.55	100.00	120.0

Front Flange

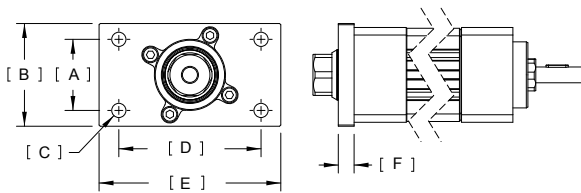

		KSFF-60	KSFF-75	KSFF-90
A	in	1.772	1.969	2.480
	mm	45.00	50.00	63.00
B	in	2.559	3.150	3.780
	mm	65.00	80.00	96.00
C	in	Ø 0.354	Ø 0.354	Ø 0.480
	mm	9.00	9.00	12.20
D	in	3.543	3.937	4.961
	mm	90.00	100.00	126.00
E	in	4.528	5.118	6.496
	mm	115.00	130.00	165.00
F	in	0.394	0.591	0.750
	mm	10.00	15.00	19.05

End Angles

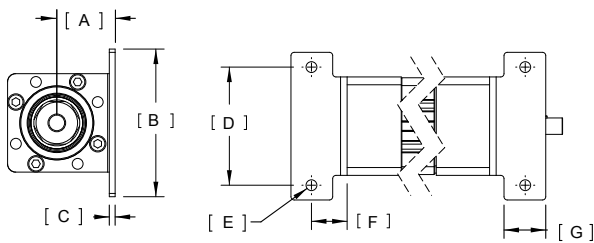

KX60 Maximum Allowable Actuator Force = 1350 lbs
KX75 Maximum Allowable Actuator Force = 2000 lbs
KX90 Maximum Allowable Actuator Force = 1350 lbs

	Inline	KSEA-60	KSEA-75	KSEA-90
	Parallel	KSEP-60	KSEP-75	KSEP-90
A	in	1.400	1.968	2.219
	mm	35.55	50.00	56.35
B	in	3.543	2.953	3.543
	mm	90.00	75.00	90.00
C	in	0.140	0.250	0.250
	mm	3.56	6.35	6.35
D	in	2.835	1.969	2.480
	mm	72.00	50.00	63.00
E	in	Ø 0.260	Ø 0.354	Ø 0.472
	mm	6.60	9.00	12.00
F	in	0.856	1.083	1.319
	mm	21.74	27.50	33.50
G	in	1.001	1.575	1.969
	mm	25.44	40.00	50.00

Rear Flange

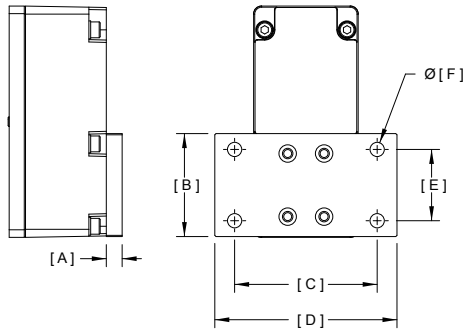

Option	A	B	C	D	E	F
KSRF-60-66	0.394 in 10.00 mm	2.559 in 65.00 mm	3.543 in 90.00 mm	4.528 in 115.00 mm	1.772 in 45.00 mm	0.354 in 9.00 mm
KSRF-60-86	0.472 in 12.00 mm	2.950 in 75.00 mm	3.937 in 100.00 mm	4.724 in 120.00 mm	1.969 in 50.00 mm	0.354 in 9.00 mm
KSRF-60-96	0.750 in 19.05 mm	3.780 in 96.00 mm	4.961 in 126.00 mm	6.496 in 165.00 mm	2.480 in 63.00 mm	0.480 in 12.2 mm
KSRF-75-86	0.590 in 15.00 mm	3.150 in 80.00 mm	3.937 in 100.00 mm	5.118 in 130.00 mm	1.969 in 50.00 mm	0.354 in 9.00 mm
KSRF-75-96	0.750 in 19.05 mm	3.780 in 96.00 mm	4.961 in 126.00 mm	6.496 in 165.00 mm	2.480 in 63.00 mm	0.480 in 12.2 mm
KSRF-75-130	0.750 in 19.05 mm	4.370 in 111.00 mm	5.906 in 150.00 mm	7.323 in 186.00 mm	2.953 in 75.00 mm	0.561 in 14.25 mm
KSRF-90-96	0.750 in 19.05 mm	3.780 in 96.00 mm	4.961 in 126.00 mm	6.496 in 165.00 mm	2.480 in 63.00 mm	0.480 in 12.2 mm
KSRF-90-130	0.750 in 19.05 mm	4.370 in 111.00 mm	5.906 in 150.00 mm	7.323 in 186.00 mm	2.953 in 75.00 mm	0.561 in 14.25 mm

Rear Clevis

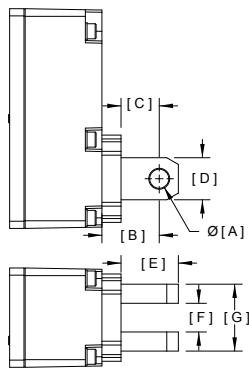

Rear Eye

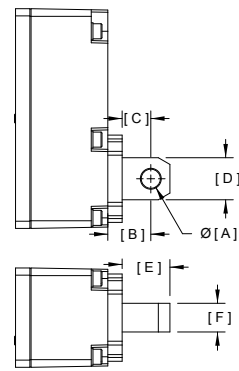

Clevis and Eye Dimensions, Imperial and Metric

Option	A	B	C	D	E	F	G
Inch Clevis (KSRC-60)	0.500 in +0.004/+0.002	1.500 in	1.000 in	1.100 in	1.500 in	0.750 in +0.020/-0.000	1.750 in +0.000/-0.029
Metric Clevis (KSMC-60)	12 mm +0.04/-0.0	25.00 mm	16.00 mm	24.00 mm	28.00 mm	28.00 mm +0.52/-0.00	52.00 +0.00/-0.74 mm
Inch Eye (KSRE-60)	0.500 in +0.004/+0.002	1.125 in	0.750 in	1.100 in	1.250 in	0.750 in +0.008/-0.024	NA
Metric Eye (KSME-60)	12 mm +0.04/-0.0	25.00 mm	16.00 mm	24.00 mm	28.00 mm	28.00 mm +0.20/-0.60	NA
Inch Clevis (KSRC-75)	0.751 in +0.001/+0.000	2.000 in	1.375 in	1.250 in	2.000 in	1.251 in +0.005/-0.001	2.500 in
Metric Clevis (KSMC-75)	16 mm +0.04 mm/-0.0	36.00 mm	20.00 mm	30.00 mm	40.00 mm	40.00 +0.41/-0.00 mm	70.00 mm
Inch Eye (KSRE-75)	0.751 in +0.001/+0.000	2.000 in	1.375 in	1.250 in	2.000 in	1.250 in +0.000/-0.005	NA
Metric Eye (KSME-75)	16 mm +0.04 mm/-0.0	36.00 mm	20.00 mm	30.00 mm	34.00 mm	39.80 -0.20/-0.60 mm	NA
Inch Clevis (KSRC-90)	0.750 in +0.001/+0.000	2.000 in	1.375 in	1.450 in	2.100 in	1.251 in +0.005/-0.001	3.544 in
Metric Clevis (KSMC-90)	16 mm +0.04 mm/-0.0	36.00 mm	20.00 mm	36.00 mm	37.00 mm	50.00 +0.41/-0.00 mm	90.00 mm
Inch Eye (KSRE-90)	0.750 in +0.001/+0.000	2.000 in	1.375 in	1.450 in	2.100 in	1.250 in +0.000/-0.005	NA
Metric Eye (KSME-90)	16 mm +0.04 mm/-0.0	36.00 mm	20.00 mm	36.00 mm	37.00 mm	50.00 -0.20/-0.60 mm	NA

Spherical Rod Eye

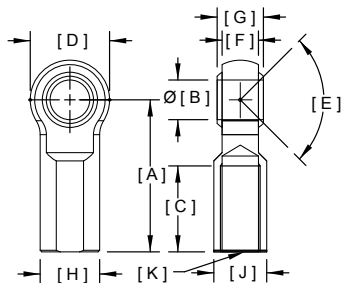

	KX60 (SRM050)	KX75 (SRM075)	KX90 (SRM075)
A	2.125 in (54.0 mm)	2.875 in (73.03 mm)	2.875 in (73.03 mm)
$\varnothing B$	0.500 in (12.7 mm)	0.750 in (19.05 mm)	0.750 in (19.05 mm)
C	1.156 in (29.4 mm)	1.625 in (41.28 mm)	1.625 in (41.28 mm)
D	1.312 in (33.3 mm)	1.75 in (44.5 mm)	1.75 in (44.5 mm)
E	6°	14°	14°
F	0.500 in (12.7 mm)	0.688 in (17.46 mm)	0.688 in (17.46 mm)
G	0.625 in (15.9 mm)	0.875 in (22.23 mm)	0.875 in (22.23 mm)
H	0.875 in (22.2 mm)	1.125 in (28.58 mm)	1.125 in (28.58 mm)
J	0.750 in (19.1 mm)	1.000 in (25.40 mm)	1.000 in (25.40 mm)
K	1/2-20	3/4-16	3/4-16

KX Series Linear Actuators

Rod Eye

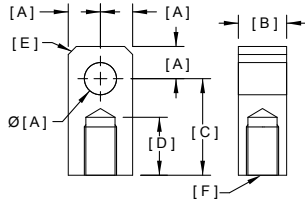

	KX60 (REI050)	KX75 (RE075)	KX90 (RE075)
$\varnothing A$	0.50 in (12.7 mm)	0.750 in (19.05 mm)	0.750 in (19.05 mm)
B	0.75 in (19.05 mm)	1.250 in (31.75 mm)	1.250 in (31.75 mm)
C	1.50 in (38.1 mm)	2.375 in (60.33 mm)	2.375 in (60.33 mm)
D	0.75 in (19.05 mm)	1.125 in (28.58 mm)	1.125 in (28.58 mm)
E	0.375 in (9.53 mm)	3/4-16	3/4-16
F	1/2-20	NA	NA

Rod Clevis

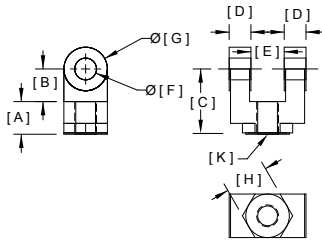

	KX60 (RCI050)	KX75 (RC075)	KX90 (RC075)
A	0.750 in (19.05 mm)	1.125 in (28.58 mm)	1.125 in (28.58 mm)
B	0.750 in (19.05 mm)	1.250 in (31.75 mm)	1.250 in (31.75 mm)
C	1.500 in (38.1 mm)	2.375 in (60.33 mm)	1.750 in (44.45 mm)
D	0.500 in (12.7 mm)	0.625 in (15.88 mm)	0.625 in (15.88 mm)
E	0.765 in (19.43 mm)	1.265 in (32.13 mm)	1.265 in (32.13 mm)
$\varnothing F$	0.500 in (12.7 mm)	0.750 in (19.05 mm)	0.750 in (19.05 mm)
$\varnothing G$	1.000 in (25.4 mm)	1.500 in (38.10 mm)	1.500 in (38.10 mm)
H	1.000 in (25.4 mm)	1.250 in (31.75 mm)	1.250 in (31.75 mm)
$\varnothing J$	N/A	N/A	N/A
K	1/2-20	3/4-16	3/4-16

Clevis Pin

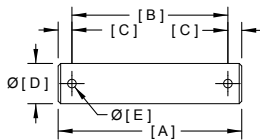

	KX60		KX75		KX90	
	KSMP-60	KSRP-60	KSMP-75	KSRP-75	KSMP-90	KSRP-90
A	2.56 in (65 mm)	2.28 in (57.9 mm)	3.35 in (85.0 mm)	3.09 in (78.5 mm)	4.13 in (105.0 mm)	4.13 in (105.0 mm)
B	2.19 in (55.50 mm)	1.94 in (49.28 mm)	2.99 in (76.0 mm)	2.74 in (69.5 mm)	3.78 in (96.0 mm)	3.78 in (96 mm)
C	0.19 in (4.75 mm)	0.17 in (4.32 mm)	0.18 in (4.5 mm)	0.18 in (4.5 mm)	0.18 in (4.5 mm)	0.18 in (4.5 mm)
$\varnothing D$	0.47 in (12 mm)	0.50 in (12.7 mm)	0.630 in +0.000/-0.002 (16 mm +0.00/-0.04)	0.750 in +0.000/-0.002 (19.05 mm +0.00/-0.04)	0.630 in +0.000/-0.002 (16 mm +0.00/-0.04)	0.750 in +0.000/-0.002 (19.05 mm +0.00/-0.04)
$\varnothing E$	0.12 in (3 mm)	0.095 in (2.41 mm)	0.14 in (3.56 mm)	0.14 in (3.56 mm)	0.14 in (3.56 mm)	0.14 in (3.56 mm)

Rod Ends

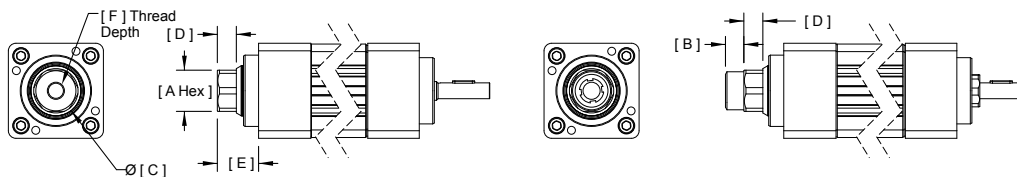

	Thread	A Hex	B	$\varnothing C$ Rod	D	E	F
KX60							
M/W	U.S. Male 1/2-20 UNF-2A	1.02 in (28.00 mm)	0.875 in (22.2 mm)	1.249 in (31.74 mm)	0.472 in (12.00 mm)	1.025 in (26.04 mm)	N/A
F/V	U.S. Female 1/2-20 UNF-2B	1.02 in (28.00 mm)	N/A	1.249 in (31.74 mm)	0.472 in (12.00 mm)	1.025 in (26.04 mm)	0.75 in (19.0 mm)
A/R	Metric Male M12 x 1.25 6g	1.02 in (28.00 mm)	0.945 in (24 mm)	1.249 in (31.74 mm)	0.472 in (12.00 mm)	1.025 in (26.04 mm)	N/A
B/L	Metric Female M12 x 1.25 6H	1.02 in (28.00 mm)	N/A	1.249 in (31.74 mm)	0.472 in (12.00 mm)	1.025 in (26.04 mm)	0.70 in (17.80 mm)
KX75							
M/W	U.S. Male 3/4-16 UNF-2A	1.18 in (30.00 mm)	1.125 in (28.58 mm)	1.500 in (38.10 mm)	0.551 in (14.00 mm)	1.300 in (33.03 mm)	N/A
F/V	U.S. Female 3/4-16 UNF-2B	1.18 in (30.00 mm)	N/A	1.500 in (38.10 mm)	0.551 in (14.00 mm)	1.300 in (33.03 mm)	1.13 in (28.58 mm)
A/R	Metric Male M16 x 1.50 6g	1.18 in (30.00 mm)	1.260 in (32.00 mm)	1.500 in (38.10 mm)	0.551 in (14.00 mm)	1.300 in (33.03 mm)	N/A
B/L	Metric Female M16 x 1.50 6H	1.18 in (30.00 mm)	N/A	1.500 in (38.10 mm)	0.551 in (14.00 mm)	1.300 in (33.03 mm)	1.30 in (33.00 mm)
KX90							
M/W	U.S. Male 3/4-16 UNF-2A	1.34 in (34.00 mm)	1.50 in (38.10 mm)	1.750 in (44.45 mm)	0.629 in (16.00 mm)	1.611 in (40.91 mm)	N/A
F/V	U.S. Female 3/4-16 UNF-2B	1.34 in (34.00 mm)	N/A	1.750 in (44.45 mm)	0.629 in (16.00 mm)	1.611 in (40.91 mm)	1.25 in (31.75 mm)
A/R	Metric Male M20 x 1.5 6g	1.34 in (34.00 mm)	1.417 in (36.00 mm)	1.750 in (44.45 mm)	0.629 in (16.00 mm)	1.611 in (40.91 mm)	N/A
B/L	Metric Female M20 x 1.5 6H	1.34 in (34.00 mm)	N/A	1.750 in (44.45 mm)	0.629 in (16.00 mm)	1.611 in (40.91 mm)	1.50 in (38.10 mm)

Motor Mount Drawing

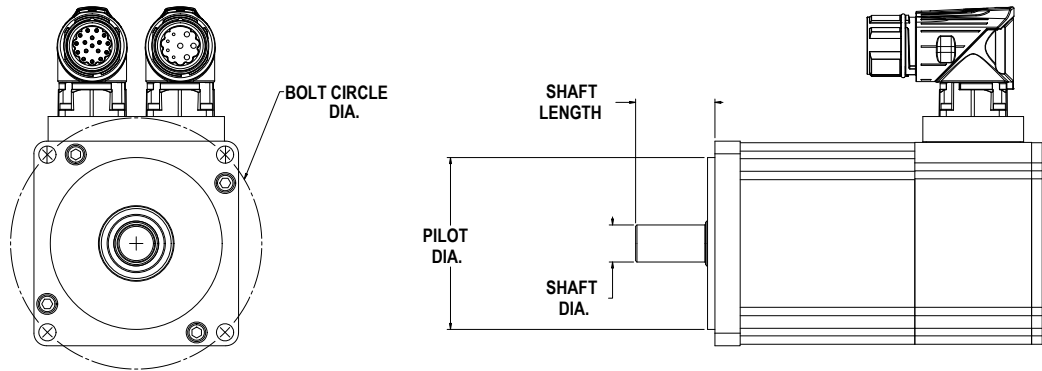

KX60 Motor Mount Codes

Bolt Circle Diameter (mm)	Pilot Diameter (mm)	Shaft Diameter (mm)	Shaft Length (mm)	Key Width (mm)	Motor Mount Code
63	45	14	38	5	GEB
63	50a	12	36	4	GEA
68	60	12	30	4	GFB
68	60	16	48	5	GFA
70	50	14	30	5	JGA
70	50	16	30	5	GGB
70	50	16	37	5	GGA
75	60	14	30	5	IHB
90	60	19	40	6	JKF
90	70	14	30	5	JKD
90	70	16	35	NA	JKC
90	70	16	40	5	JKG
90	70	19	40	6	JKA
95	50	14	30	5	ILA
95	65	14	30	5	ILA
100	80	10	32	3	IMD
100	80	14	30	5	IMA
100	80	14	40	5	JMC
100	80	16	40	5	IMB
100	80	19	40	6	IMC

KX Series Linear Actuators

KX75 Motor Mount Codes

Bolt Circle Diameter (mm)	Pilot Diameter (mm)	Shaft Diameter (mm)	Shaft Length (mm)	Key Width (mm)	Motor Mount Code
68	60	16	48	5	GFA
70	50	16	40	5	GGA
75	60	16	48	5	GHA
85	70	22	56	6	GIA
90	60	19	40	6	JKF
90	70	16	40	5	JKG
90	70	19	40	6	JKA
100	80	14	40	5	JMC
100	80	16	40	5	IMB
100	80	19	40	6	IMC
100	80	19	55	6	JMD
100	80	22	48	6	GMA
115	95	19	40	6	INA
115	95	19	55	6	JNC
115	95	22	45	8	JND
115	95	22	70	NA	JNB
115	95	24	45	8	JNA
115	95	24	50	8	INB
130	95	19	40	6	IPC
130	95	24	50	8	IPD
130	110	19	40	6	IPA
130	110	24	50	8	IPB
145	110	19	40	6	JQJ
145	110	19	55	5	JQG
145	110	19	55	6	JQK
145	110	22	55	8	JQH
145	110	22	55	6	JQF
145	110	22	70	8	JQE

KX90 Motor Mount Codes

Bolt Circle Diameter (mm)	Pilot Diameter (mm)	Shaft Diameter (mm)	Shaft Length (mm)	Key Width (mm)	Motor Mount Code
70	50	16	40	5	GGA
75	60	16	48	5	GHA
85	70	22	56	6	GIA
90	60	19	40	6	JKF
90	70	16	40	5	JKG
90	70	19	40	6	JKA
100	80	14	40	5	JMC
100	80	16	40	5	IMB
100	80	19	40	6	IMC
100	80	19	55	6	JMD
100	80	20	40	6	GMB
100	80	22	48	6	GMA
115	95	19	40	6	INA
115	95	19	55	6	JNC
115	95	22	45	8	JND
115	95	22	70	NA	JNB
115	95	24	45	8	JNA
115	95	24	50	8	INB
130	95	19	40	6	IPC
130	95	24	50	8	IPD
130	110	19	40	6	IPA
130	110	24	50	8	IPB
145	110	19	40	6	JQJ
145	110	19	55	5	JQG
145	110	19	55	6	JQK
145	110	22	55	8	JQH
145	110	22	55	6	JQF
145	110	22	70	8	JQE
145	110	24	55	8	JQD
145	110	24	65	8	JQC
145	110	28	55	8	JQB
145	110	28	63	8	JQA

KX Series

KX Series Ordering Guide

[Return to Table of Contents](#)

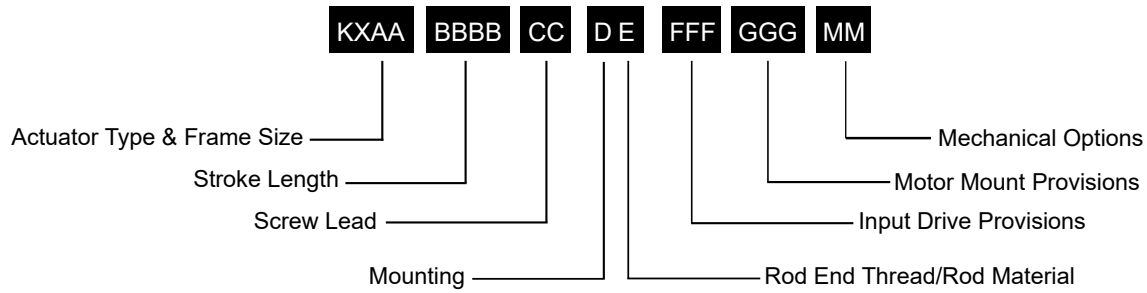

Actuator Series

KX = High Capacity Roller Screw

AA = Actuator Frame Size

60 = 60 mm (2.375 inch)
75 = 75 mm (2.95 inch)
90 = 90 mm (3.54 inch)

BBBB = Stroke Length (mm)

0150 = 150 mm (5.9 inch)
0300 = 300 mm (11.8 inch)
0600 = 600 mm (23.6 inch)
0900 = 900 mm (35.4 inch)

CC = Lead (linear motion per screw revolution)

05 = 5 mm (0.2 inch)
10 = 10 mm (0.4 inch)

D = Mounting Options

N = None, Base Unit

E = Rod Options

M = Male, US Standard thread
A = Male Metric thread
F = Female US Standard thread
B = Female Metric thread

FFF = Input Drive Provisions

NMT = Drive shaft only, no motor mount
ISC = Inline, includes shaft coupling
Keyed Motor Shaft Options
P10 = Parallel, 1:1 belt reduction
P20 = Parallel, 2:1 belt reduction
Smooth Motor Shaft Options
S10 = Parallel, 1:1 belt reduction
S20 = Parallel, 2:1 belt reduction

GGG = Motor Mount Provisions ¹

See page 135-137 for Motor Mount Code.

MM = Mechanical Options ²

PB = Protective bellows for extending rod

Limit Switches

L1 = One N.O., PNP
L2 = Two N.C., PNP
L3 = One N.O. PNP & two N.C., PNP
L4 = One N.O., NPN
L5 = Two N.C., NPN
L6 = One N.O., NPN & two N.C., NPN

*See Page 129 for Limit Switch details.



For options or specials not listed above or for extended temperature operation, please contact Exlar

NOTES:

1. For oversized motors, contact your local sales representative.
2. For extended temperature operation consult factory for model number.

Please provide a 3D CAD model of motor with all orders to ensure proper mounting compatibility.